

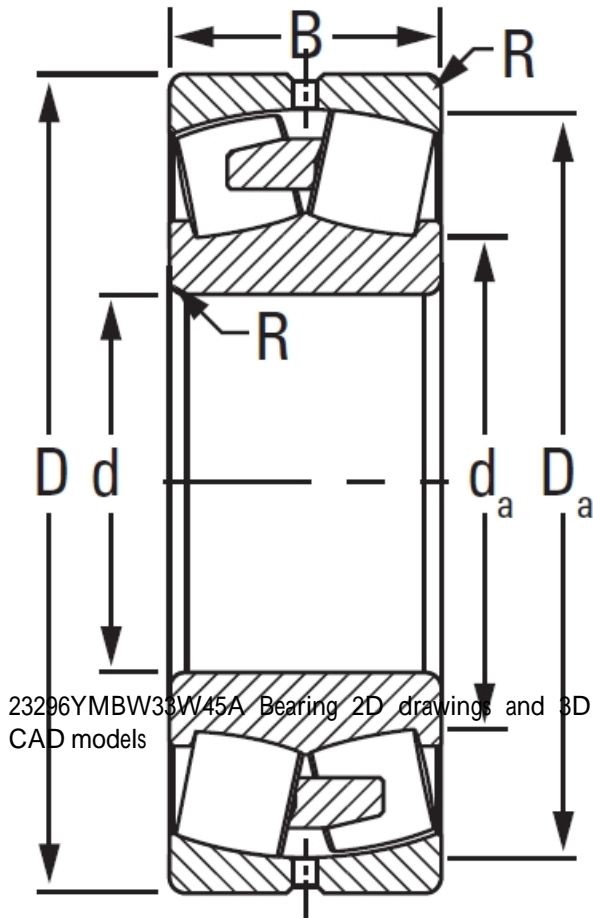

JOP BEARING MFG. CORP.

23296YMBW33W45A TIMKEN Spherical Roller Bearings Steel Cage

Bearing No. 23296YMBW33W45A



23296YMBW33W45A Bearing 2D drawings and 3D CAD models

Design Unit	METRIC
Bearing Weight	821.200 Kg
Cage Type	YMB
UPC Code	087796360426
Cage Material	Brass
d	480.000 mm
D	870.000 mm
B - Inner Ring Width	310 mm
B - Outer Ring Width	310.000 mm
R - Inner Ring To Clear Radius ¹	6.000 mm
r - Outer Ring To Clear Radius ²	6.000 mm
da - Inner Ring Backing Diameter	561.000 mm
Da - Outer Ring Backing Diameter	779.000 mm
C0 - Static Radial Rating	16400000 N
C1(2) - Dynamic Radial Rating (Two-Rows)	9860000 N
e - ISO Factor ³	0.35
Y0 - ISO Factor ⁴	1.92
Y1 - ISO Factor ⁵	2.85
Y2 - ISO Factor ⁶	1.87
Reference Thermal Speed Rating (Grease)	260
Reference Thermal Speed Rating (Oil) ⁷	280



JOP BEARING MFG.CORP.

Cg - Geometry Factor ⁸	0.1072
-----------------------------------	--------