

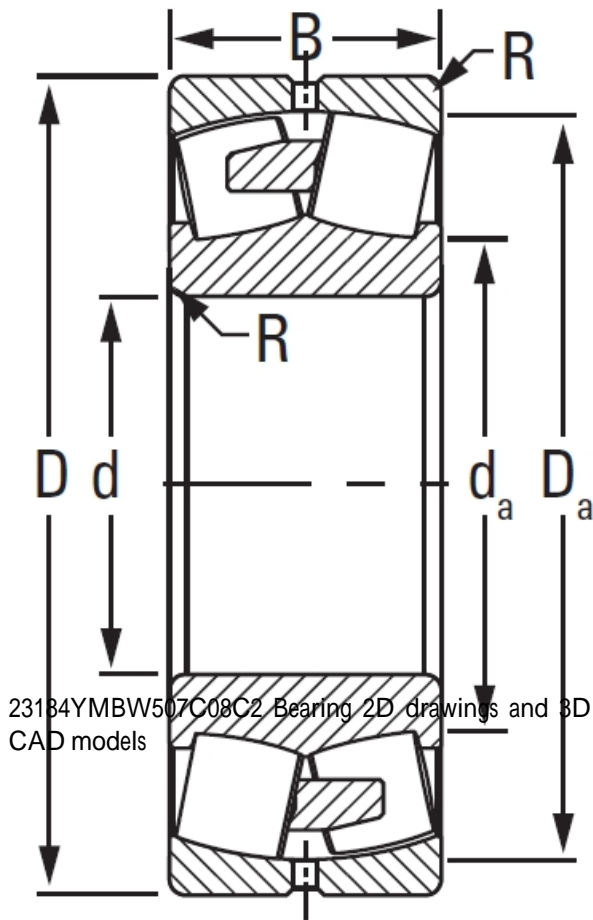

JOP BEARING MFG. CORP.

23184YMBW507C08C2 TIMKEN Tapered Roller Bearings Tapered Single Imperial

Bearing No. 23184YMBW507C08C2



23184YMBW507C08C2 Bearing 2D drawings and 3D CAD models

Design Unit	METRIC
Bearing Weight	350.800 Kg
Cage Type	YMB
UPC Code	087796188204
Cage Material	Brass
d	420.000 mm
D	700.000 mm
B - Inner Ring Width	224 mm
B - Outer Ring Width	224.000 mm
R - Inner Ring To Clear Radius ¹	5.000 mm
r - Outer Ring To Clear Radius ²	5.000 mm
da - Inner Ring Backing Diameter	480.000 mm
Da - Outer Ring Backing Diameter	636.000 mm
C0 - Static Radial Rating	9640000 N
C1(2) - Dynamic Radial Rating (Two-Rows)	5720000 N
e - ISO Factor ³	0.31
Y0 - ISO Factor ⁴	2.21
Y1 - ISO Factor ⁵	3.2
Y2 - ISO Factor ⁶	2.16
Reference Thermal Speed Rating (Grease)	440
Reference Thermal Speed Rating (Oil) ⁷	480



JOP BEARING MFG.CORP.

Cg - Geometry Factor ⁸	0.0957
-----------------------------------	--------